

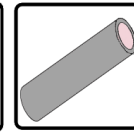

M-081 2309 EU

Patent Pending



[mm]

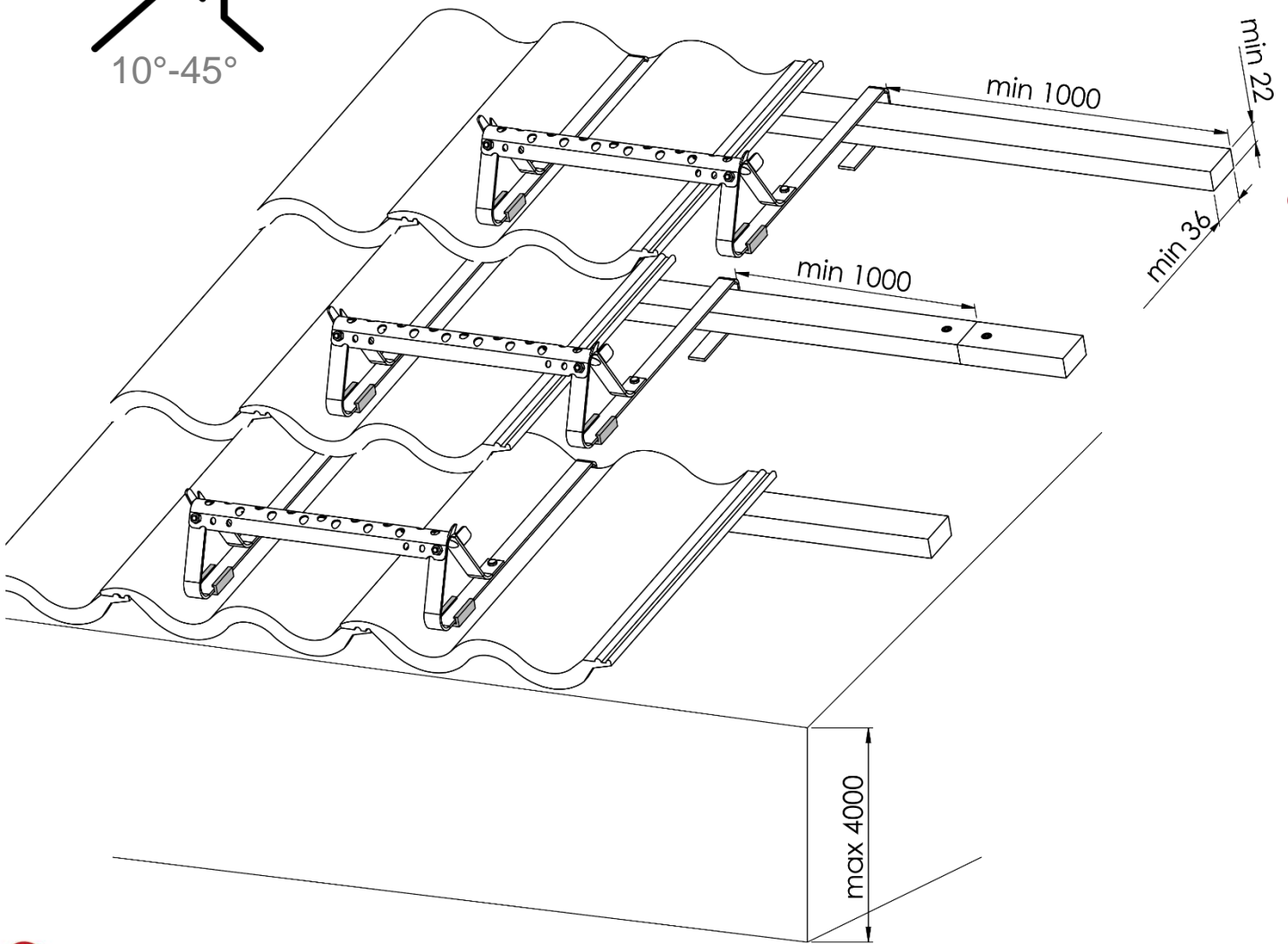
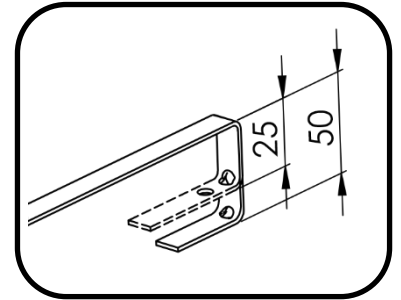
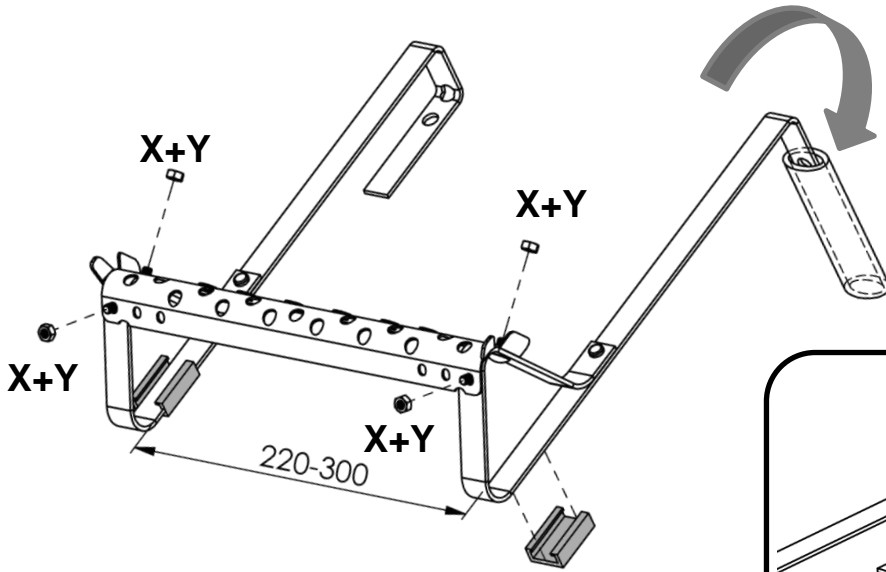

cwlundberg.com

