

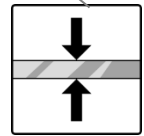

M-285-1 2311

M-283 M-291 M-368

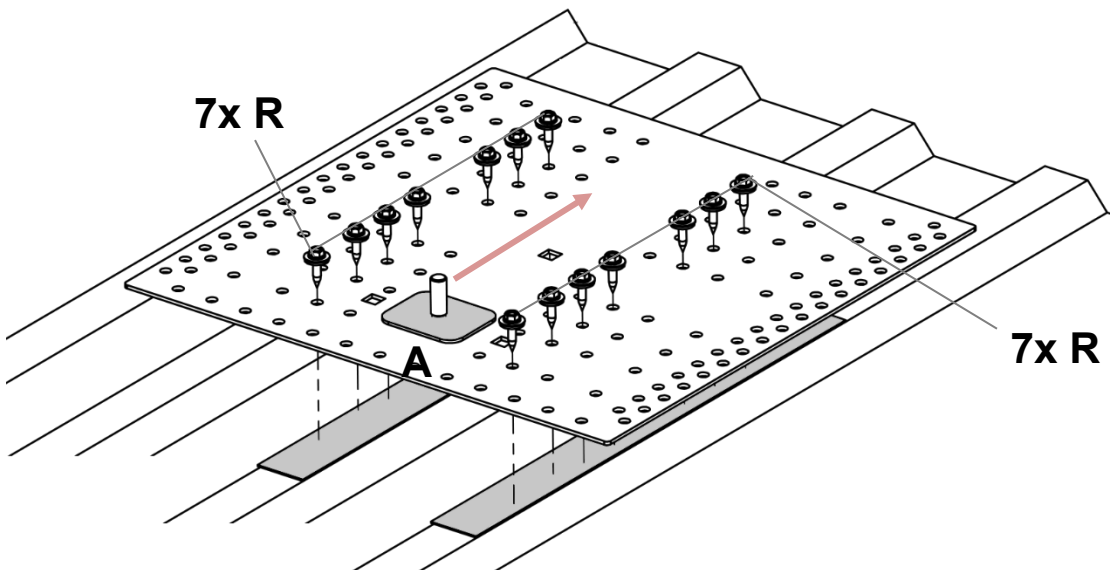
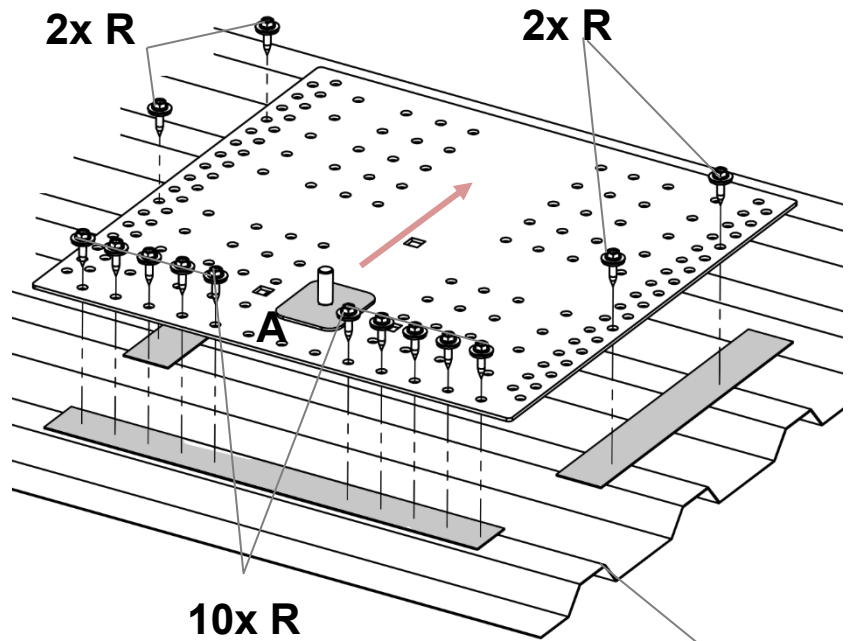
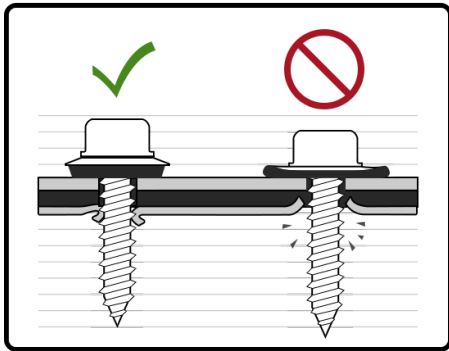

Fe min 0.5
Al min 0.8

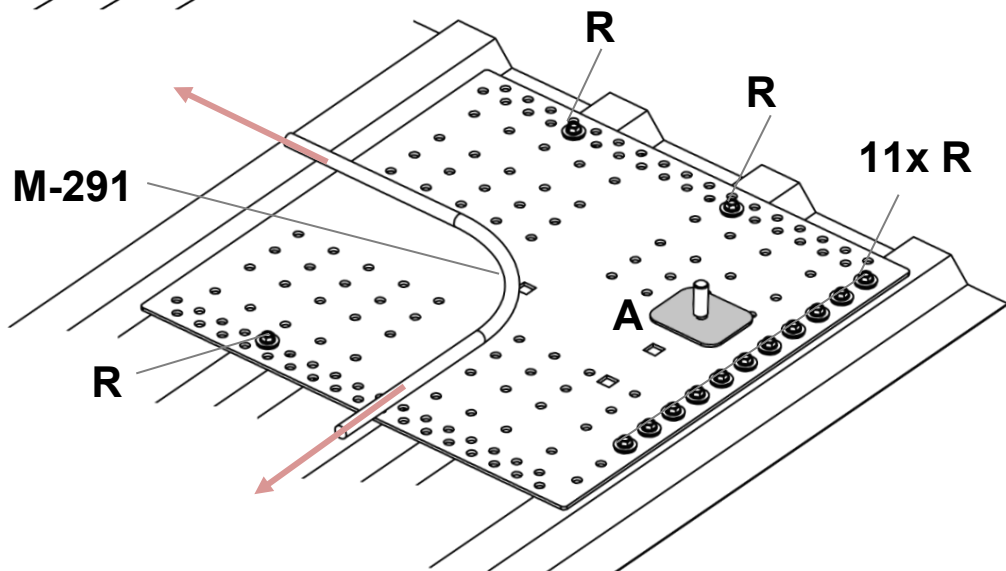

cwlundberg.com



M-285-2 2311

M-283 M-291 M-368

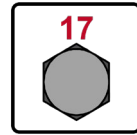

[mm]



A=
M10x32
A2



B=
10,5x20
A2



C=
M10
A2



A+B+C

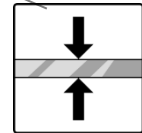
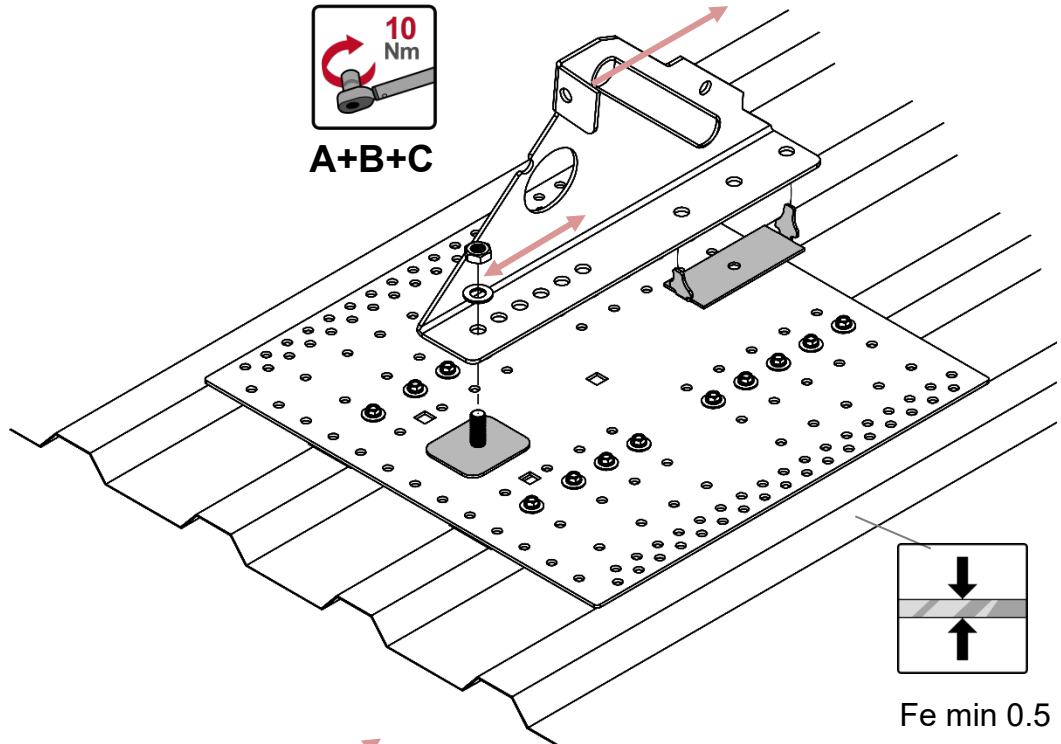

Fe min 0.5
Al min 0.8



R=
6,3x19
A2

4x R

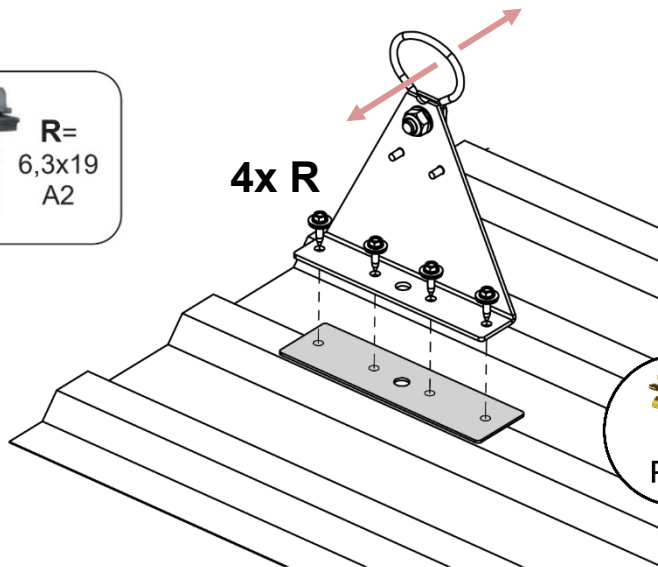

A+B+C

